

# MANUEL D'UTILISATION

## GROUPES ELECTROGENES ESSENCE

GG1500/GG3000

BG2000/BG2000ECO/BG3000

GG4500 GG6200/BG6000R

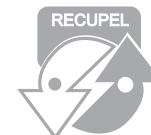

# CONTENU

1. INFORMATIONS DE SÉCURITÉ
2. COMPOSANTS
3. CONTRÔLES AVANT UTILISATION
4. DÉMARRAGE DU MOTEUR
5. ARRÊT DU MOTEUR
6. ENTRETIEN PÉRIODIQUE
7. PROBLÈMES
8. SPÉCIFICATIONS

## 1. INFORMATION DE SÉCURITÉ

**AVANT TOUT ESSAIE DE FONCTIONNEMENT DE VOTRE MACHINE, LIRE IMPERATIVEMENT CE MANUEL. TOUTE UTILISATION EFFECTUEE SANS LECTURE PREALABLE DE CE MANUEL RISQUE DE METTRE EN DANGER VOTRE VIE OU D'ENDOMMAGER VOTRE MACHINE.**

Soyez attentifs aux points suivants:

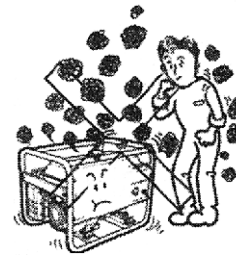

- Ne pas mettre en service dans un secteur mal aéré

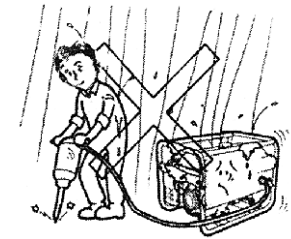

- Ne pas mettre en service avec des conditions humides

## 1. INFORMATIONS DE SÉCURITÉ

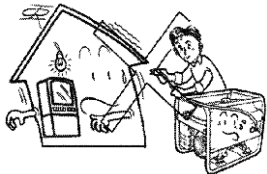

- Ne pas brancher sans couper l'alimentation du réseau.

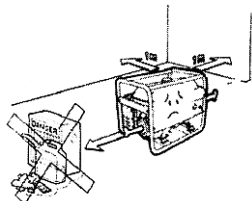

- Tenir à 1 m de distance des objets inflammables

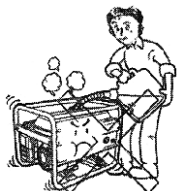

- Ne pas faire le plein d'essence moteur en marche



- Ne pas FUMER lors du remplissage



- Ne pas faire déborder le carburant

## 1. INFORMATIONS DE SÉCURITÉ

### MESURES DE SECURITE

- 1. Le combustible de l'appareil doit être de l'essence, ne pas utiliser de kérosène.**  
Essuyez le surplus d'essence avec un chiffon propre.  
Toute matière inflammable ou explosive doit être tenue à l'écart du générateur, en raison de la température élevée du moteur.  
Installer votre groupe sur une surface plate et horizontale, pour éviter des débordements d'essence.
- 2. Inhalation des gaz d'échappement:** Les gaz d'échappement contiennent du monoxyde de carbone toxique. N'utilisez jamais le groupe dans un endroit mal aéré.
- 3. Brûlures :** Ne touchez jamais le pôt d'échappement lorsque l'appareil fonctionne ou vient d'être arrêté.
- 4. Décharges, courts circuits:** Ne pas toucher votre groupe avec des mains humides. Le générateur n'est pas imperméable à l'eau, donc il ne doit pas être exposé à l'eau ou à la neige.
- 5. Autres points de sécurité:** Vous devez impérativement savoir comment arrêter votre groupe avant de l'utiliser. N'autorisez jamais quelqu'un à mettre le groupe en route sans avoir pris connaissance de ce manuel !  
Portez toujours un casque de protection, des chaussures de sécurité et gardez toujours prêt de vous des chiffons propres. Tenir les enfants et les animaux domestiques éloignés.

## 2. COMPOSANTS

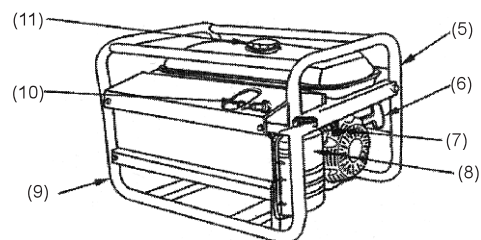
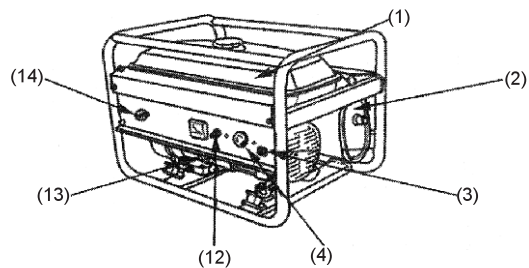

1. Réservoir d'essence	6. Poignée de démarrage	11. Bouchon d'essence
2. Echappement	7. Robinet d'essence	12. Interrupteur Mono
3. Prise de Terre	8. Filtre à air	13. Jauge d'huile
4. Prises Mono	9. Cadre	14. Démarrage
5. Carburateur	10. Bougie	

## 3. CONTRÔLES

**Controler le niveau d'huile, quand l'appareil est hors service.**

1. Prenez la jauge d'huile et la nettoyer avec un chiffon propre.

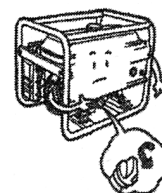

2. Replacer la jauge sans la tourner.

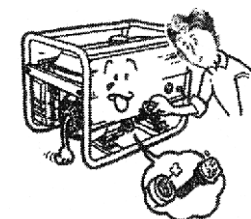

3. Si le niveau est en dessous de la marque, remplir jusqu'à celle-ci

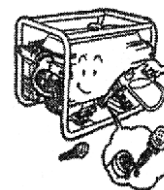

4. Replacer la jauge et tourner pour refermer.

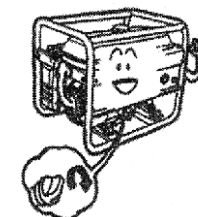

### 3. CONTRÔLES

#### Niveau d'essence

1. Ouvrir le bouchon du réservoir

2. Contrôler le niveau d'essence.

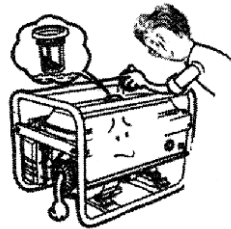
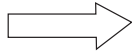
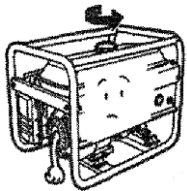

3. Remplir en combustible jusqu'au marquage du filtre à essence.

4. Revisser le bouchon du réservoir.

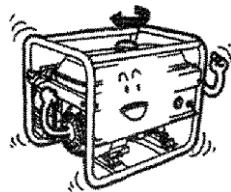
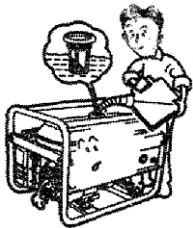

### 3. CONTRÔLES

#### Filtre à Air

1. Décliper ou dévisser le boîtier de filtre à air et enlever le filtre.

2. Enlever la vis et la rondelle, et retirer l'élément filtrant

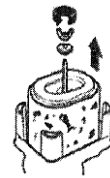
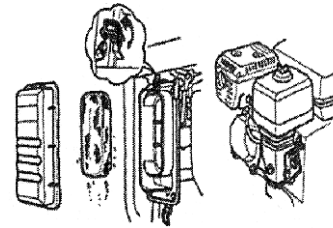

3. Démonter le filtre

4. Laver

5. Secouer lentement le filtre

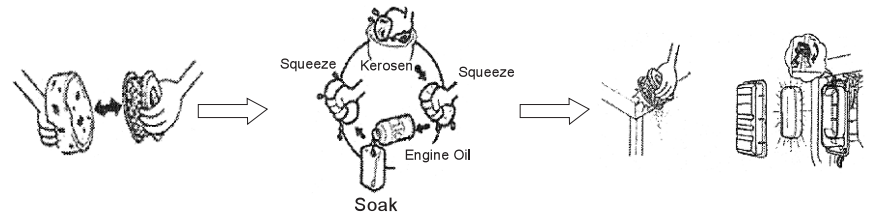

## 4 DÉMARRAGE DU MOTEUR

1. Avant la mise en service du moteur, ne pas brancher d'appareil.

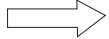
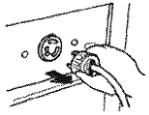

2. Placer le robinet sur "ON"

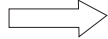
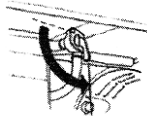

3. Placez le Starter sur la position "OPEN"

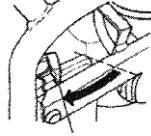

4. Placer l' interrupteur sur "ON"

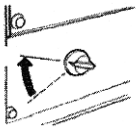

5. Tirer lentement le lanceur jusqu'à ce qu'il devienne "plus dur" puis tirer d'un coup sec.

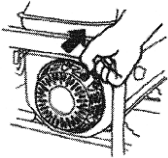

6. Remettre le "Starter" en place

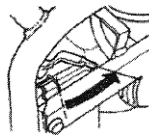

## 4 DÉMARRAGE DU MOTEUR

### MESURES DE PRÉCAUTION

1. Plusieurs appareils ne doivent pas être branchés en même temps.
2. Faites fonctionner votre Groupe pendant environ 3 minutes, sans brancher d'appareils.  
Tous les appareils électriques demandent une puissance plus élevée au démarrage.  
Les brancher les un après les autres, en respectant la puissance maximum autorisée de votre Groupe.
3. Assurez-vous que tous les appareils sont en bon état de marche avant de les brancher au Groupe.  
Si un appareil ne fonctionne plus ou s'arrête subitement, stopper IMMÉDIATEMENT votre Groupe à l'aide de l'interrupteur principal puis débrancher l'appareil et le vérifier.  
Si la valeur sur le voltmètre est trop élevée, arrêter l'appareil et vérifier le dysfonctionnement. Si la valeur inscrite sur le voltmètre est de 230V +/- 10% (50hz), le générateur peut être redémarré.
4. **Courant continu** : Ne pas utiliser le 12V en même temps que le 230V.  
Le raccordement au courant continu ne doit être utilisé que pour le chargement de "batteries rechargeables" 12 volts.  
Lors de mise en charge de batteries, assurez-vous de la bonne polarité (+ sur + et - sur -). Effectuer le branchement sur la batterie en premier, puis sur votre Groupe.
5. Le branchement de votre Groupe sur un réseau nécessite l'intervention d'un électricien. Le mauvais branchement de ce dernier peut entraîner des dégâts importants.  
ATTENTION ! Si votre groupe doit être relié à un réseau, le coupler à un inverseur de source, pour éviter tout relarguage sur le réseau et tout accident ou incendie.

## 5. ARRÊT DU MOTEUR

1. Mettre le courant alternatif hors circuit

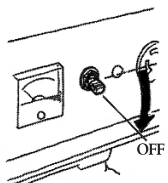

2. Positionner l'interrupteur sur "OFF"

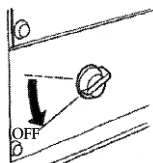

3. Tourner le robinet d'essence sur "OFF"

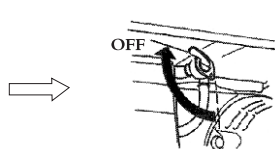

### REMARQUE :

En cas d'urgence pour arrêter votre Groupe, positionner l'interrupteur sur "OFF"

## 6. ENTRETIEN PÉRIODIQUE

Il est très important d'effectuer les contrôles et vérifications suivantes pour assurer le bon fonctionnement de votre Groupe.

Le Groupe se compose du moteur à essence, et d'une génératrice de courant alternatif, du cadre, etc.

Arrêter l'appareil, avant toute opération d'entretien. Vous assurer que votre Groupe soit situé dans un endroit aéré, pour éviter tout empoisonnement au monoxyde de carbone.

Nettoyer votre Groupe avec un chiffon sec pour éviter toute corrosion sur ce dernier.

ÉLÉMENT	Journalier	Chaque mois ou chaque 20h	Chaque 3 mois ou 50h	Chaque 6 mois ou 100h	Chaque année ou 300h
Vérifier le niveau huile moteur	o Contrôler				
Changer l'huile moteur		o Remplacer		o Remplacer	
Vérifier élément filtrant	o Contrôler				
Nettoyage filtre à essence			o Nettoyer		
Carter d'huile				o Nettoyer	
Filtre à huile				o Nettoyer	
Bougie				o Nettoyer	
Réglage bougie d'allumage					o Contrôler et ajuster
Nettoyage bougie d'allumage					o Nettoyer
Nettoyer rese voir à carburant	A remplacer tous les 3 ans si nécessaire				

## 6. ENTRETIEN PÉRIODIQUE

### Remplacer l'huile moteur

1. Dévisser puis enlever la jauge d'huile
2. Dévisser le bouchon de vidange et vider l'huile contenue dans le carter
3. Revisser le bouchon de vidange, après écoulement total.

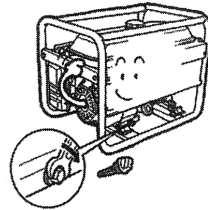
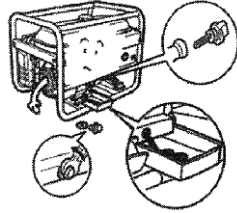
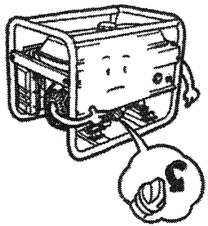

4. Remplir le carter d'huile jusqu'au niveau maxi de la Jauge

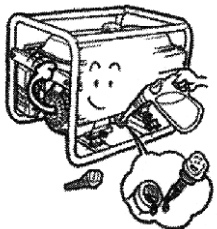

5. Repositionner la jauge puis revisser.

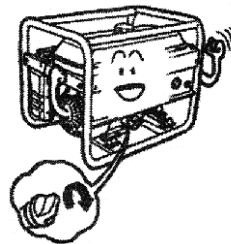

## 6. ENTRETIEN PÉRIODIQUE

Type d'huile : 4-Temps essence : huile moteur recommandée SAE 10W-30

- Filtre à air
- Bougie

1. Débrancher le câble de bougie
2. Dévisser et retirer la bougie de son logement
3. Nettoyer la bougie à l'aide d'une brosse métallique.

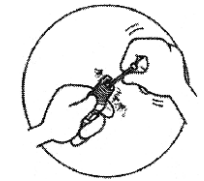
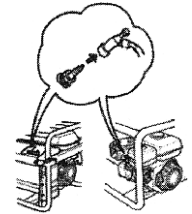

4. Vérifier l'écart de l'électrode

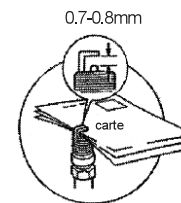

5. Remettre en place la bougie ainsi que son câble



## 6. ENTRETIEN PÉRIODIQUE

### Entretien du filtre à Essence

1. Positionner robinet d'essence sur "OFF" puis enlever le filtre à essence

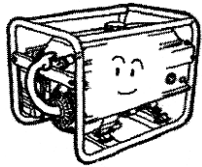

2. Nettoyer le filtre à essence .

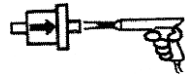

3. Remplacer le joint torique de cuve après nettoyage pour en assurer l'étanchéité.

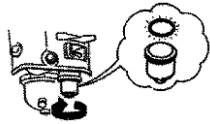

### Entretien avant un longue durée de stockage

En cas de stockage prolongé de votre Groupe effectuer les opérations suivantes:



1. Dévisser la vis de la cuve du carburateur pour en vider son contenu.
2. Dévisser le bouchon de vidange d'huile et vider l'huile du carter
3. Revisser le bouchon d'huile après remplissage d'huile neuve
4. Remplir l'huile jusqu'au niveau maxi.
5. Tirer lentement le lanceur jusqu' à sentir un point dur (cette opération à pour but de fermer les soupapes et d'éviter toute corrosion dans votre moteur).

## 7. PROBLÈMES



CAUSE		AIDE
LE MOTEUR NE DÉMARRE PAS	- Pas assez d'huile	- Le niveau est trop bas
	- L'interrupteur principal n'est pas positionné sur "ON"	- Positionner l'interrupteur principal sur "ON"
	- pas d'huile	- Vérifier et remplir le carter d'huile
	- Il n'y a pas d'allumage.	- Vérifier l'allumage et la bobine
	- Bougie encrassée	- Nettoyer la bougie à l'aide d'une brosse métallique
PAS D'ÉNERGIE	- Le disjoncteur principal n'est pas positionné sur "ON"	- placer le disjoncteur principal sur la position "ON"
	- Le contact des prises de courant est défectueux	- Rebrancher et vérifier les contacts
	- La vitesse de rotation de votre Moteur n'est pas suffisante.	- Vérifier et Ajuster

## 8. SPÉCIFICATIONS

Type	BG2000-ECO	3000	1500	BG2000	BG3000					
Voltage (V)	110 / 220, 120 / 240, 220, 230									
Fréquence (Hz)	50	60	50	60	50	60	50	60	50	60
Puissance en continu (KW)	1.8	2.1	2.3	2.5	1.0	1.1	2.0	2.3	2.6	3.0
Puissance Maxi (kw)	2.2	2.5	2.5	3.0	1.2	1.5	2.4	2.7	3.0	3.3
Alternateur (Type)	Avec balais, 2- pôles									
Moteur	Modèle	UP168	UP168II	UP90	UP160	UP170				
	Type	4 Temps essence OHV, refroidi par Air								
	Puissance Maxi (CV)	6.5	6.5	2.5	6.5	7				
	Cylindrée (cc)	196	196	87	196	208				
	Consommation d'essence	<230 g/hp.h								
	Système d'Allumage	Allumage électronique transistorisé								
	Alésage + Cylindrée	68 x 54	68 x 54	54 x 38	68 x 54	70 x 54				
	Capacité d'huile moteur	0.6 Liter	0.6 Liter	0.4 Liter	0.6 Liter	1.1 Liter				
Démarrage	Manuel par lanceur									
Réservoir de carburant	3.6 Litres		6 Litres	15 Litres						

Type	4500	6200	BG6000R			
Voltage (V)	110 / 220, 120 / 240, 220, 230					
Fréquence (Hz)	50	60	50	60	50	60
Puissance en continu (KW)	3.2	3.5	4.5	5.2	5.0	5.5
Puissance Maxi (KW)	3.8	4.5	5.2	6.2	6.0	7.2
Alternateur (Type)	Avec balais, 2- pôles					
Moteur	Modèle	UP177	UP188	UP188		
	Type	4 Temps essence OHV, refroidi par Air				
	Puissance Maxi (CV)	9.0	13	13		
	Cylindrée (cc)	270	389	389		
	Consommation d'essence	<230 g/hp.h				
	Système d'Allumage	Allumage électronique transistorisé				
	Alésage + Cylindrée	77 x 58	88 x 64	88 x 64		
	Capacité d'huile moteur	1.1 Liter	1.1 Liter	1.1 Liter		
Démarrage	Manuel par lanceur	Manuel par lanceur et électrique				
Réservoir de carburant	25 Litres					

### GARANTIE

Pour les clauses de garantie, reportez-vous aux conditions de garantie ci-jointes.

### ENVIRONNEMENT

 Si, après un certain temps, vous décidez de remplacer votre machine, ne vous en débarrassez pas avec les ordures ménagères mais destinez-la à un traitement respectueux de l'environnement.

Rue de Gozée, 81  
6110 Montigny-le-Tilleul  
Belgique

Tél : 0032 71 29 70 70  
Fax : 0032 71 29 70 86



Site S.A.V. D.N.V. Website  
**www.eco-repa.com**  
Your after sale partner

FR

Vous trouverez les mises à jour des modes d'emploi, les vues éclatées ainsi que des informations concernant les pièces de rechange sous : [www.eco-repa.com](http://www.eco-repa.com)

NL

U kunt updates van handleidingen, exploded views en informatie over onderdelen onder : [www.eco-repa.com](http://www.eco-repa.com)

GB

You can find updates of manuals, exploded views and information on spare parts under : [www.eco-repa.com](http://www.eco-repa.com)

D

zu

Sie können Updates von Handbüchern zu finden, Explosionszeichnungen und Informationen Ersatzteilen unter : [www.eco-repa.com](http://www.eco-repa.com)

IT

È possibile trovare gli aggiornamenti dei manuali, esplosi e informazioni su pezzi di ricambio in: [www.eco-repa.com](http://www.eco-repa.com)

ES

Usted puede encontrar actualizaciones de los manuales, explotó opiniones e información sobre piezas de recambio en : [www.eco-repa.com](http://www.eco-repa.com)

P

Você pode encontrar atualizações de manuais, vistas explodidas e informações sobre peças de reposição sob : [www.eco-repa.com](http://www.eco-repa.com)



81, rue de Gozée  
6110 Montigny-le-Tilleul  
Belgique

Tél : 0032 71 29 70 70

Fax : 0032 71 29 70 86

**Made in China**

**S.A.V**

 32 / 71 / 29 . 70 . 88

 32 / 71 / 29 . 70 . 99



**Service Parts separated**

 32 / 71 / 29 . 70 . 83

 32 / 71 / 29 . 70 . 86

2010

**Made in China**

# BENZINEGENERATOR



## HANDLEIDING

**BG2000 BG2000ECO BG3000 BG6000R**

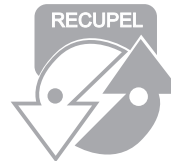

# INHOUDSOPGAVE

DEEL 1	VEILIGHEIDSTIPS
DEEL 2	ONDERDELEN EN COMPONENTEN
DEEL 3	CONTROLE VOOR GEBRUIK
DEEL 4	DE GENERATOR STARTEN
DEEL 5	DE GENERATOR STOPPEN
DEEL 6	PERIODIEKE CONTROLE EN ONDERHOUD
DEEL 7	PROBLEMEN OPLOSSEN
DEEL 8	ALGEMENE SPECIFICATIES
DEEL 9	GEBRUIKS- EN VERKOOPSVOORWAARDEN

## DEEL 1 VEILIGHEIDSTIPS

Bedankt dat u voor onze benzinegenerator hebt gekozen. Lees deze handleiding aandachtig voor u de generator gaat gebruiken en leer de belangrijkste regels van het gebruik en het onderhoud van de machine uit het hoofd.

Waarschuwing: Wanneer u de opmerkingen in deze handleiding en de veiligheidsvoorschriften niet opvolgt, kan dit leiden tot lichamelijke verwondingen of ernstige schade aan de machine. Lees de volgende punten aandachtig:



- \* Gebruik de machine nooit in een gesloten of slecht geventileerde ruimte.



- \* Gebruik de machine niet in natte weersomstandigheden (regen, sneeuw).



\* Sluit de machine nooit aan op het elektriciteitsnet van uw woning als de stroom niet is uitgeschakeld.

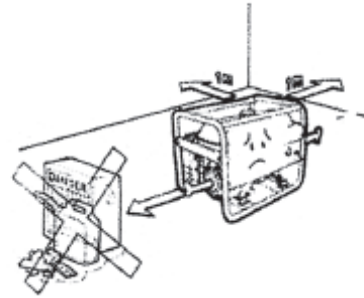

\* Houd minimaal 1 meter verwijderd van ontvlambare stoffen.

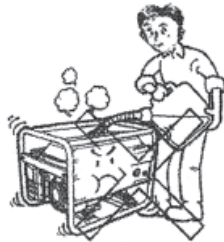

\* Zet de motor van de generator uit voor u brandstof bijvult.



\* Niet roken tijdens het bijvullen.



\* Zorg ervoor dat u geen brandstof knoeit.

## Voorzorgsmaatregelen:

### 1. Voorkom brand

De generator loopt op benzine. Brandstoffen als diesel en kerosine kunnen dus niet worden gebruikt. Veeg brandstofresten weg als u tijdens het bijvullen hebt geknoeid. Gebruik hiervoor een schone doek. Houd alle brandstoffen, explosieve stoffen en ontvlambare stoffen ver van de generator, want de temperatuur

in de buurt van de uitlaat kan erg hoog worden wanneer de generator in werking is.

Gebruik de generator op een waterpas oppervlak. Er zou benzine uit de tank kunnen lopen als de machine niet waterpas staat.

### 2. Voorkom dat u uitlaatgassen inademt

Uitlaatgassen bevatten giftig koolmonoxide. Gebruik de generator daarom nooit in slecht verluchte ruimtes. Gebruik de generator bij voorkeur buitenshuis. Zorg voor voldoende ventilatie met schone lucht wanneer u de generator toch binnenshuis moet gebruiken.

### 3. Voorkom brandwonden

Raak nooit de geluiddemper of de kap van de geluiddemper aan wanneer de machine in werking is, of net is stopgezet.

### 4. Elektrische schokken en kortsluiting

Om elektrische schokken en kortsluiting te voorkomen mag u de generator nooit aanraken wanneer deze nat is of wanneer u natte handen hebt. Deze generator is niet waterdicht en mag daarom nooit worden gebruikt op plaatsen waar hij wordt blootgesteld aan regen, sneeuw of waterspetters. De generator moet worden geaard om elektrische schokken te voorkomen.

Sluit een lange, zware kabel aan tussen de aardeaansluiting van de generator en een losse aardingsvoorziening.

Sluit geen andere toestellen op de generator aan voor u de generator hebt aangezet.

### 5. Overige veiligheidstips

Leer uit uw hoofd hoe u de generator snel moet uitzetten en hoe alle knoppen werken. Laat nooit iemand anders met de generator werken zonder nauwkeurig aan deze persoon uit te leggen hoe de generator werkt.

Draag altijd veiligheidsschoenen en geschikte kleding. Houd kinderen en huisdieren op een veilige afstand van de generator wanneer deze in werking is.



## DEEL 2 ONDERDELEN EN COMPONENTEN

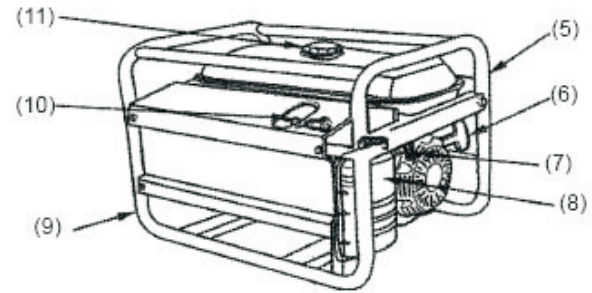
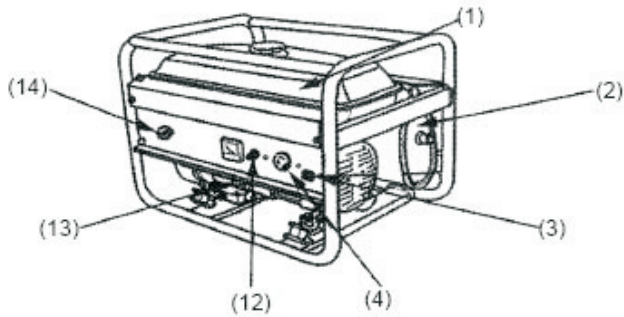

1. brandstoftank    2. geluiddemper    3. aardeaansluiting    4. A.C stekker/contactdoos    5. carburateurklep  
6. starthendel    7. brandstofkraan    8. luchtfilter    9. steunbuis    10. bougie  
11. dop van de brandstoftank    12. AC stroomonderbreker    13. peilstok    14. startschakelaar

## DEEL 3 CONTROLE VOOR GEBRUIK

### \* Oliepeil van de machine

Controleer altijd nadat u de generator hebt uitgezet het oliepeil, op een waterpas oppervlak.

1. Schroef het filterdeksel los en maak de peilstok schoon met een schone doek.

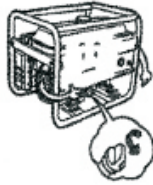

2. Zet de peilstok terug in het oliefiltergat zonder te draaien.



3. Als het oliepeil lager is dan de laagste markering op de peilstok, moet u bijvullen tot de bovenste markering.



4. Draai het filterdeksel weer vast.

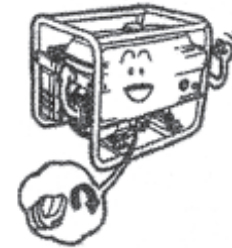

## \* Brandstofpeil

1. Open de dop van de brandstoftank.

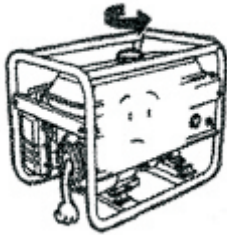

2. Controleer het brandstofpeil en vul bij indien nodig.

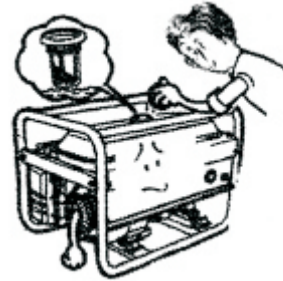

3. Vul bij tot de bovenkant van de brandstoffilter.

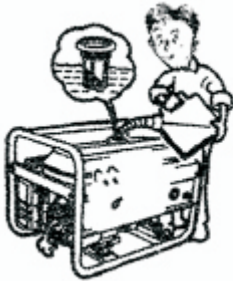

4. Draai de dop van de brandstoftank terug.

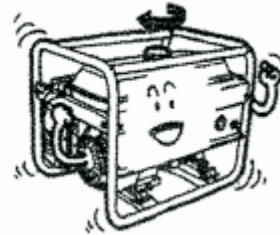

## \* Luchtfilter

1. Haal de clip los en haal de luchtfilter los of draai de moeren los en verwijder en de afdekking van de luchtfilter.

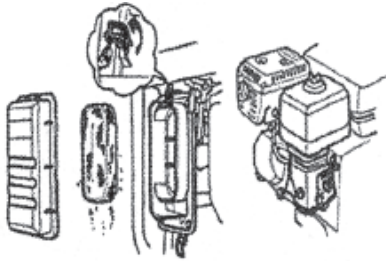

2. Haal de moer en de afdichtring los en haal de filter uit elkaar.



3. Haal de filter uit elkaar.



4. Was de filter.

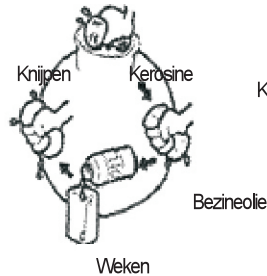

5. Klop de filter voorzichtig uit.

Knijpen

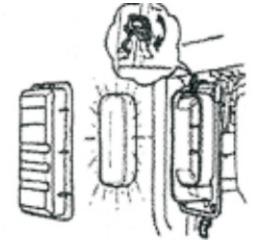

## DEEL 4 DE GENERATOR STARTEN

1. Haal de stekker(s) uit de SC contactdoos en zet de AC stroomonderbreking uit.



2. Zet de brandstofkraan op "on" "open (choke)".

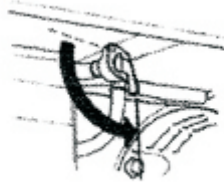

3. Zet de chokeknoop op "open (choke)".

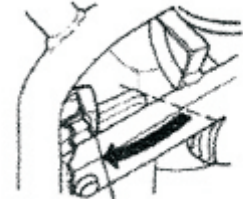

Carburateurklep

4. Zet de startknop van de generator op "on".

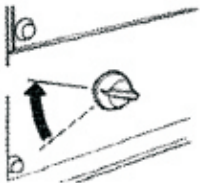

5. Trek aan de starthendel tot u weerstand voelt, en trek hem dan snel en volledig uit.

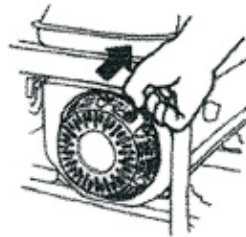

6. Zodra de generator start, zet u de chokeknoop op "off".

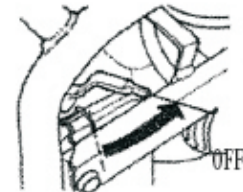

## Tips en voorzorgsmaatregelen voor het gebruik:

1. Zet nooit twee of meer machines tegelijkertijd in werking. Zet de machines een voor een aan.
2. Laat de motor drie minuten voorverwarmen zonder hem te belasten. Als de generator meer dan één toestel van stroom moet voorzien, sluit dan het toestel dat het meeste stroom verbruikt als eerste aan. Sluit daarna het tweede toestel aan.  
De meeste motoren van apparaten hebben meer stroom nodig om op te starten dan voor hun normale werking. Overschrijft de stroomlimiet per contactdoos niet.
3. Controleer of alle toestellen in een goede staat zijn voor u ze op de generator aansluit. Als een toestel een abnormale werking vertoont (langzaam werkt of plotseling stopt), zet de generator dan onmiddellijk uit. Haal daarna pas het toestel los en controleer het op schade of tekenen van slijtage.  
Als het stroomnet overbelast raakt en de AC stroomkringbeveiliging springt, zet dan minder stroom op het circuit en wacht een paar minuten voor u weer begint te werken.  
Als de voltmeter te hoog staat, zet de machine dan stop en controleer of er schade aan is. De generator kan opladen wanneer de voltmeter op 230V ± 10% (50Hz) staat op het controlepaneel.
4. DC toepassing: gebruik nooit tegelijkertijd DC 12V en AC.  
De DC terminal kan alleen gebruikt worden om herlaadbare 12 volt-accu's op te laden. Als u herlaadbare accu's met een accukabel oplaadt, haal dan de min-pool van de accu af voor u hem oplaadt. Draai de kabels om de accu op te laden niet om: dit veroorzaakt ernstige schade aan de generator en/of aan de accu.
5. Als u de generator op het stroomnet van uw woning wilt aansluiten, laat dit dan doen door een ervaren technicus. Een onjuiste aansluiting tussen de generator en een toestel kan schade aan het toestel en/of aan de accu veroorzaken, en kan leiden tot brand.

Waarschuwing: als de generator op een gewoon stroomnet moet worden aangesloten, moet u de hoofdschakelaar afzetten. Anders kan de stroomtoevoer van uw gewone stroomnet schade veroorzaken aan de generator en/of aangesloten toestellen, en kan leiden tot brand.

## DEEL 5 DE GENERATOR STOPPEN

1. Zet de AC stroomonderbreking uit.
2. Zet de schakelaar van de generator op "off"
3. Zet de brandstofkraan op "off".

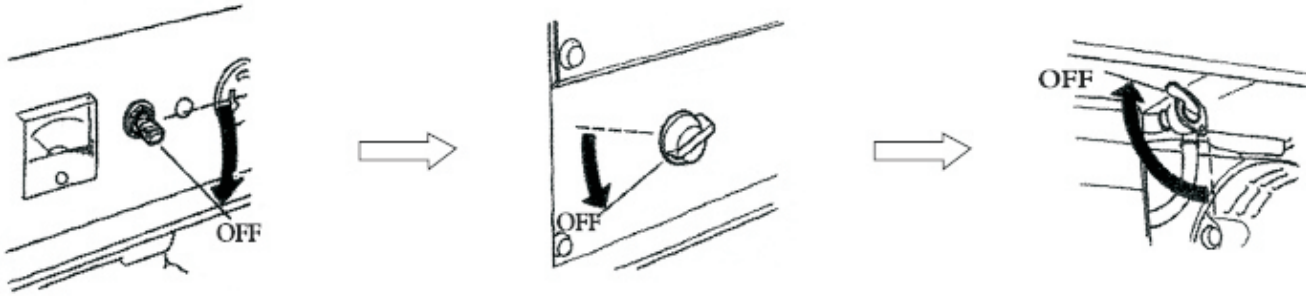

**Opmerking:** om de generator stop te zetten bij een noodgeval zet u de schakelaar van de generator op "off".

## DEEL 6 PERIODIEKE CONTROLE EN ONDERHOUD

### \* PERIODIEKE CONTROLE EN ONDERHOUD

Periodieke controles en onderhoud aan de machine zijn erg belangrijk om de machine in een goede staat te houden en om de werking betrouwbaar te houden. De generator bestaat uit een benzinemotor, een alternator, een controlepaneel, een frame en meer. Zet de motor uit voor u onderhoud aan de machine uitvoert. Als u de machine aanzet, zorg dan voor voldoende toevoer van frisse lucht in de ruimte. De uitlaatgassen bevatten giftig koolmonoxide. Maak de motor meteen na gebruik schoon met een doek om roestvorming te voorkomen en om vuil te verwijderen.

Controle	Dagelijkse controle	20 werkuren of na	50 werkuren of iedere	100 werkuren of iedere	300 werkuren of
Controle van machineolie		eerste maand	3 maanden	6 maanden	1 keer per jaar
Motorolie vervangen	* controle				
Controle luchtfilter		* vervangen		* vervangen	
Luchtfilter wassen	* controle				
Oliefilterbakje			* schoonmaken	* schoonmaken	
Oliefilter				* schoonmaken	
Bougie				* schoonmaken	
Klepspelning					* controleren/aanpassen
Cilinderdeksel wassen					* schoonmaken
Brandstoftank uitwassen	Indien nodig uitwassen, iedere 3 jaar vervangen				



## \* De machineolie vervangen

1. Draai de peilstok los en haal hem eruit.

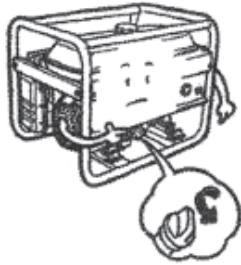

2. Draai de aftapstop los, en leeg de machineolie in de carterpan.

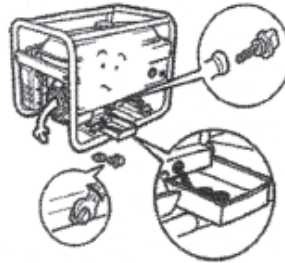

3. Draai de aftapstop vast.

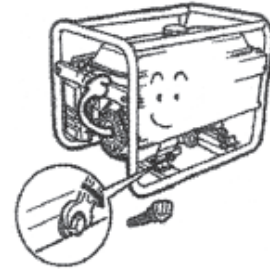

4. Vul de machineolie bij tot bovenaan.



5. Zet de peilstok terug.

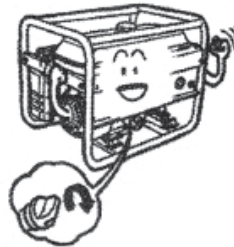

Machineolie: Viertaktmotorolie SE, SF van API Service Classification of SAE 10W-30, het equivalent van de SG -klasse.

Bij lage werktemperaturen (kouder dan 10°C): gebruik SAE 10W-30-machineolie.

Bij ijskoude werktemperaturen (kouder dan -15°C): gebruik SE, SF van API Service Classification of SAE10W-30, het equivalent van de SG-klasse.

\* Luchtfilter (zie pagina 8: Luchtfilter

\* Bougie

1 Haal de isolator van de bougie

2. Haal de bougie uit elkaar.

3. Verwijder koolstofreften.

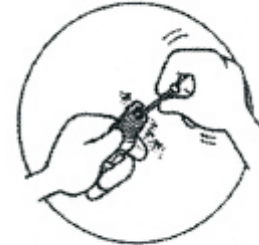
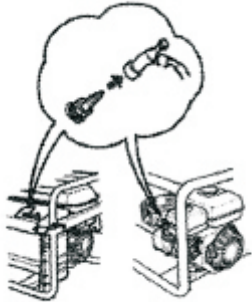

4. Meet de elektrodenafstand.

0,7 - 0,8 mm

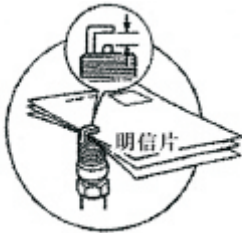

5. Zet de bougie en de isolatie terug.



\* Onderhoud van de brandstoffilter

1. Zet de brandstofkraan op "off" en verwijder het filterbakje.

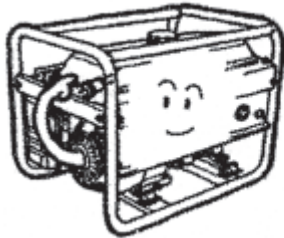

2. Maak het filterbakje goed schoon.

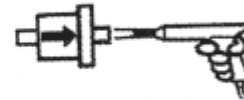

3. Zet er een nieuwe rubberen ring in en sluit de filter goed.

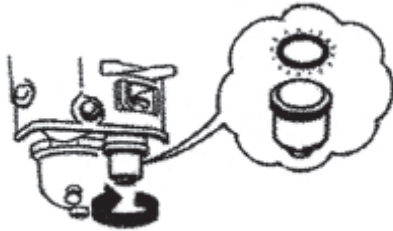

\* Onderhoudsbeurt vóór u de machine voor een lange periode opbergt

Als u de generator voor een lange periode wilt opbergen, moet u het volgende onderhoud uitvoeren:

1. Draai de brandstofaftapstop los en leeg de brandstof in de carburateur.
2. Draai de filterplug en de olieaftapstop los en leeg de machineolie in de carterpan.
3. Draai de olieaftapstop weer vast.
4. Vul de machineolie bij tot het hoogste vulpeil op de peilstok.
5. Trek zacht aan de starthendel tot u weerstand voelt.

## DEEL 7 PROBLEMEN OPLOSSEN

Oorzaak		Oplossing
Motor kan niet starten	Te weinig brandstofolie	Vul de brandstof bij
	De knop staat niet op "on"	Zet de schakelaar op "on".
	Te weinig smeeroilie	Controleer smeeroilie en vul bij tot een voldoende niveau.
	Te weinig kracht en snelheid om het startmechanisme aan te trekken.	Zet de motor aan volgens de aanwijzingen in de handleiding.
	Er zit koolafzetting op de bougie	Haal de bougie uit elkaar, controleer op koolafzetting en maak hem schoon.
Er wordt geen stroom opgewekt	De hoofdschakelaar is niet	Zet de hoofdschakelaar op "on".
	De stekker maakt geen goed contact.	Controleer de pootjes van de stekker.
	De generator krijgt niet genoeg stroom.	Pas de stroomtoevoer aan de specificaties van de machine aan.

# DEEL 8 ALGEMENE SPECIFICATIES

Model		1800		2000		BG2000-ECO		BG2000		3000		BG3000		4500		6200		BG6000R	
Voltage (V)		110/220, 120/240, 220, 230																	
Frequentie (Hz)		50	60	50	60	50	60	50	60	50	60	50	60	50	60	50	60	50	60
Gemiddelde output (KW)		1,3	1,5	1,5	1,7	1,8	2,1	2,0	2,3	2,2	2,4	2,6	3,0	3,2	3,5	4,5	5,2	5,0	5,5
Max. output (KW)		1,5	1,8	1,8	2,0	2,2	2,5	2,4	2,7	2,6	3,0	3,0	3,3	3,8	4,5	5,2	6,2	6,0	7,2
Motor	Model	168						170						177		188			
	TYPE	Luchtgekoeld, viertakt, OHV, 1 cilinder, benzine																	
	Max. kracht	6,5 pk						7 pk						9,0pk		13,0 pk			
	Inhoud	196 cc						208cc						270 cc		389 cc			
	Brandstofverbruik	≤230 g/hp.h																	
	Ontsteking	Transistorontsteking zonder contact																	
	Boring * slag	68x54						70 x54						73 x58		88 x64			
	Smeerolie	0,6 liter												1,1 liter					
	Startmechanisme	Recoil						Trekstarter of elektrisch											
Inhoud brandstoftank		3,6						15 liter						25 liter					



## **GARANTIE**

Voor de garantiebepalingen wordt verwezen naar de bijgevoegde garantievoorwaarden.



## **MILIEU**

Als uw machine na verloop van tijd aan vervanging toe is, geef hem dan niet met het huisvuil mee, maar zorg voor een milieuvriendelijke verwerking.



---

***BUILD WORKER***  
***81, rue de Gozée***  
***6110 Montigny-le-Tilleul***  
***BELGIQUE***  
***Tél : 0032 71 29 70 70 Fax : 0032 71 29 70 86***  
***Made in China***



Site S.A.V. D.N.V. Website  
**www.eco-repa.com**  
Your after sale partner

**FR**

Vous trouverez les mises à jour des modes d'emploi, les vues éclatées ainsi que des informations concernant les pièces de rechange sous : [www.eco-repa.com](http://www.eco-repa.com)

**NL**

U kunt updates van handleidingen, exploded views en informatie over onderdelen onder : [www.eco-repa.com](http://www.eco-repa.com)

**GB**

You can find updates of manuals, exploded views and information on spare parts under : [www.eco-repa.com](http://www.eco-repa.com)

**D**

Sie können Updates von Handbüchern zu finden, Explosionszeichnungen und Informationen zu Ersatzteilen unter : [www.eco-repa.com](http://www.eco-repa.com)

**IT**

È possibile trovare gli aggiornamenti dei manuali, esplosi e informazioni su pezzi di ricambio in: [www.eco-repa.com](http://www.eco-repa.com)

**ES**

Usted puede encontrar actualizaciones de los manuales, explotó opiniones e información sobre piezas de recambio en : [www.eco-repa.com](http://www.eco-repa.com)

**P**

Você pode encontrar atualizações de manuais, vistas explodidas e informações sobre peças de reposição sob : [www.eco-repa.com](http://www.eco-repa.com)





81, rue de Gozée  
6110 Montigny-le-Tilleul  
Belgique

Tél : 0032 71 29 70 70

Fax : 0032 71 29 70 86

**Made in China**

**S.A.V**

 32 / 71 / 29 . 70 . 88

 32 / 71 / 29 . 70 . 99



**Service Parts separated**

 32 / 71 / 29 . 70 . 83

 32 / 71 / 29 . 70 . 86

**2010**

**Made in China**



# **GASOLINE GENERATOR**

**BG2000 BG2000ECO BG3000 BG6000R**

OPERATIONAL MANUAL

# CONTENTS

PART 1	SAFETY TIPS
PART 2	PARTS AND COMPONENTS INTRODUCTION
PART 3	INSPECTION BEFORE OPERATION
PART 4	STARING OF GENERATOR
PAET 5	STOPPING OF GENERATOR
PART 6	PERIODIC CHECKS AND MAINTENANCE
PART7	TROUBLESHOOTING
PART8	MAIN SPECIFICATIONS
PART9	TERMS & CONDITIONS OF SALE & USE

## PART 1 SAFETY TIPS

Thank you for choosing our gasoline generator. Please read this manual carefully before use, and master the correct methods and tips of operation and maintenance.

Cautions: Not following the notes and safety precautions listed below may result in personal injury or severe engine damage. Please pay close attention to the following:

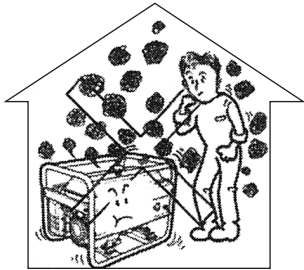

- \* Never operate in an enclosed/ poorly-ventilated area.

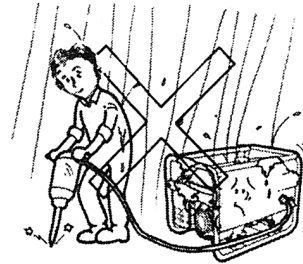

- \* Do not operate under wet climate (rain, snow).

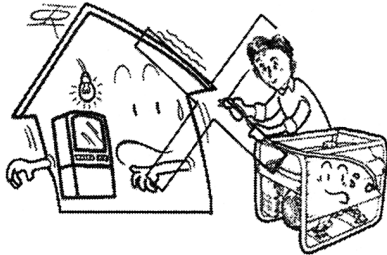

\* Never connect to house power circuit if commercial power supply is not cut.

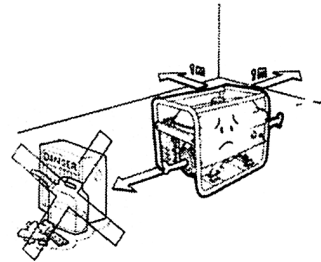

\* Keep at least 1 meter away from inflammables.

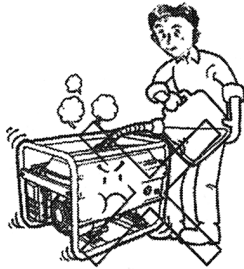

\* Remember to stop engine before fueling.

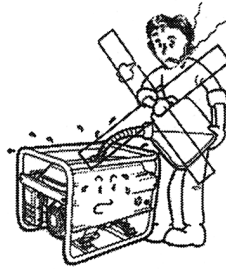

\* No smoking when fueling.

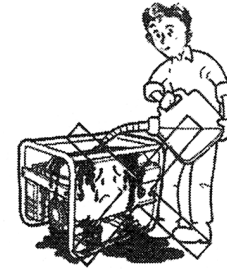

\* Avoid spilling out when fueling.

## **Precaution:**

### **1.Preventing fires**

The fuel of the engine is gasoline and hence diesel,kerosene etc must not be used.Wipe away all fuel spills with clean cloth.Keep all the fuel and explosives and inflammables away from the generator,because the temperature around the exhaust muffler may be high during operation.

Operate the generator on a level surface.There may be fuel spillage if generator is tilted.

### **2.Preventing exhaust gas inhalation**

Exhaust gas contains poisonous carbon monoxide.Never use the generator in poorly ventilated area.

Avoid indoor operation where possible and provide proper ventilation.

### **3.Preventing burning**

Never touch the muffler or muffler cover while the engine is running or just stopped.

### **4.Electric shocks,short circuits**

In order to avoid electric shocks or short circuit,do not touch the generator when either it or your hands are wet.

This generator is not waterproof,so it should not be used in a place exposed to rain,snow or water sprays.

The generator should be ground to prevent electric shocks.Please connect a length of heavy wire between the generator's ground terminal and an external ground device.

Do not connect other devices to the generator before start it.

### **5.Other safety points**

Know how to stop the generator quickly and understand how to operate all of the controls.Never permit anyone to operate the generator without proper instruction.

Always wear safety shoes and proper cloths.Keep children and pets away from the generator when it is in operation.

## PART 2 PARTS AND COMPONENTS INTRODUCTION

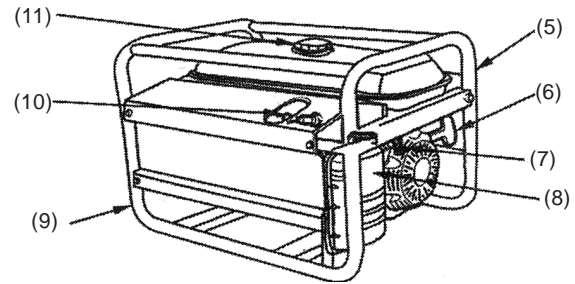
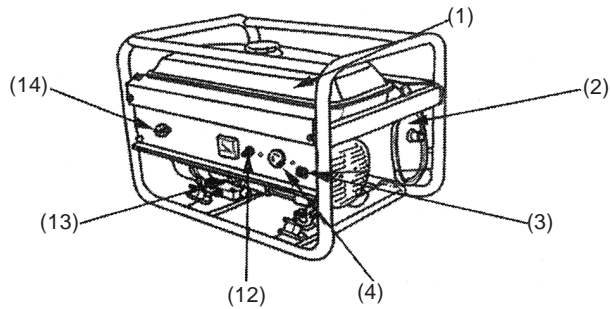

- |                  |               |                  |                   |                             |
|------------------|---------------|------------------|-------------------|-----------------------------|
| 1.fuel tank      | 2.muffler     | 3.earth terminal | 4.A.C plug/socket | 5.carburetor throttle valve |
| 6.starter handle | 7.fuel cock   | 8.air cleaner    | 9.pipe support    | 10.spark plug               |
| 11.fuel tank cap | 12.AC.breaker | 13.dipstick      | 14.starter switch |                             |

## PART 3 INSPECTION BEFORE OPERATION

### \* Machine oil level

Always check to machine oil level after stopping generator on a level ground.

1. Turn out the oil filter cap and clean the dipstick with a clean cloth.

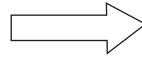
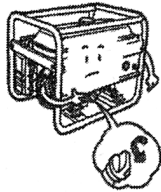

2. Insert the dipstick back into the oil filter hole without turning.

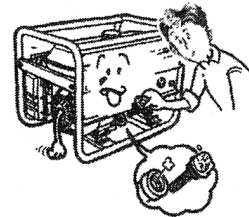

3. In the case that the oil level is below the lower level mark of the dipstick, refuel to the upper level mark.

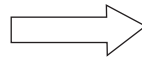
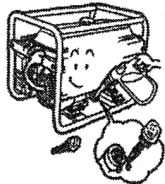

4. Reinstall the oil filter cap.

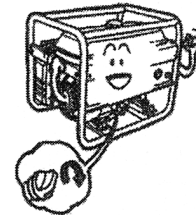



\* **Fuel oil level**

1. Open the fuel tank cap.

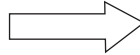
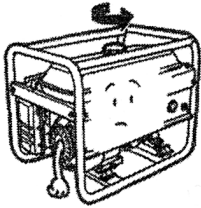

2. Check the fuel oil level, and refuel if necessary.

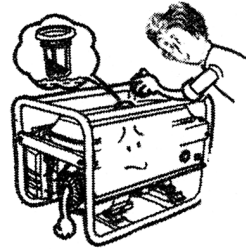

3. Refuel up to the shoulder of the fuel filter.

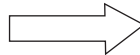
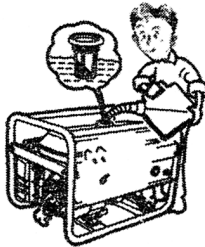

4. Reinstall the fuel tank cap.

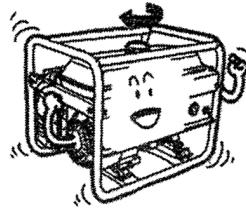

## \* Air cleaner

1.Remove the clip and dismantle the air cleaner housing or turn off the nuts and air cleaner cover.

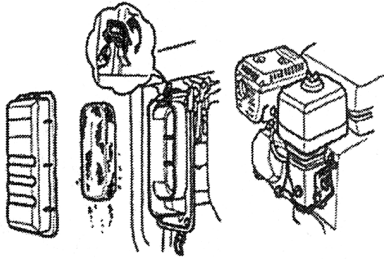

2.Turn off the nut and washer, and dismantle the filter element.

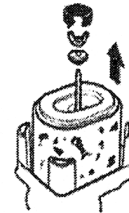

3.Dismantle the filter element.

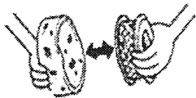

4.Wash

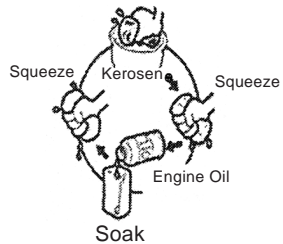

5.Slap slightly the filter element for several times.

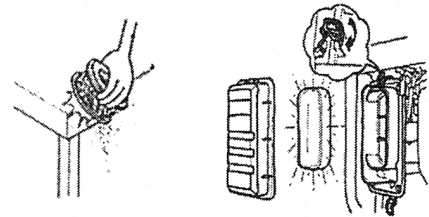

## PART 4 STARTING OF GENERATOR

1.Remove all the loads from A.C socket and switch off the A.C breaker.

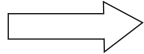
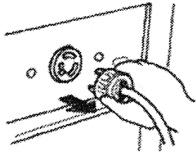

2.Set the fuel cock to "on" position.

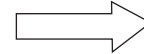
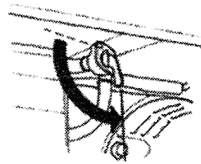

3.Push the choke lever to "open(choke)" position.

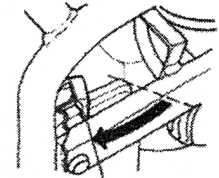

Carburetor throttle valve

4.Turn the generator start switch to "on" position.

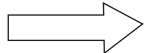
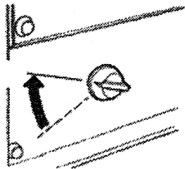

5.Pull the starter handle until resistance is felt,then pull it out swiftly and thoroughly.

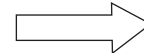
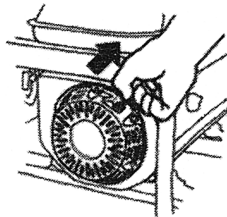

6.Once the generator starts,set the choke level to "off" position.

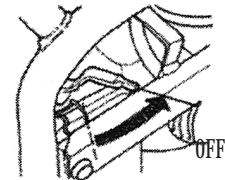

## Tips and cautions for operating :

1. Do not start two or more machines simultaneously. Start them one by one.
2. Warm up the engine without load for about 3 minutes. If the generator is to supply power to more than one appliances, be sure to connect them one by one with higher current rated first.  
Most appliance motors require more than their rated wattage for start up. Do not exceed the current limit specified for any one socket.
3. Be sure that all appliances are in good working condition before connecting them to the generator. If an appliance begins to operate abnormally (becomes sluggish, or stops suddenly), turn off the generator main switch immediately. Then disconnect the appliance and examine it for signs of malfunction.  
If overloading of the circuit trips the AC circuit protector, reduce the electric load on the circuit, and wait a few minutes before resuming operation.  
If the indication of voltmeter is too low or too high, stop the machine and examine it for cause of malfunction. The generator can load when the indicator of voltmeter show at  $230 \pm 10\%$  (50hz) on the panel of control box.
4. DC application: Do not use DC 12v and AC at the same time.  
The DC terminal may be used for charging 12 volt automatic-type batteries only. When using automatic-type batteries with battery cables, be sure to disconnect the minus pole batter from the battery before charging. Do not reverse the charging cables, or serious damage to the generator and/or battery may occur.
5. When connect the generator to home power circuit, be sure that a skilled electrician does the job. Improper connecting between the generator and appliance may cause damage of the generator or appliance, and even a fire accident.  
Warning: if the generator has to be connected to commercial power grid, make sure that the chief power switch must be shut off. Otherwise the sudden recovery of commercial power supply may cause damage to generator or appliance, and even a fire accident.

## PART 5 STOPPING OF GENERATOR

1. Switch off the AC breaker.

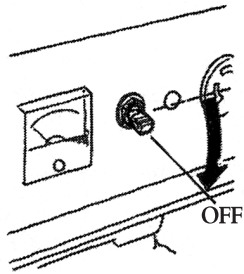

2. Turn the generator switch to "off" position.

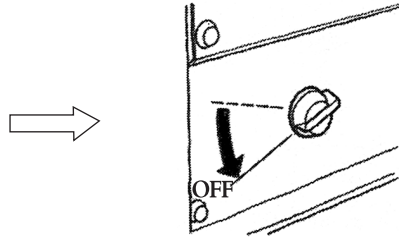

3. Set the fuel cock to "off" position.

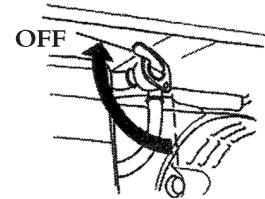

Note: To stop the generator in emergency, turn the generator switch to "off" position.

## PART 6 PERIODIC CHECKS AND MAINTENANCE

### \* PERIODIC CHECKS AND MAINTENANCE

Periodic checks and maintenance are very important for keeping the engine in good condition and dependable. The generator consists of gasoline engine, alternator, control panel and frame, etc.

Shut off the engine before performing any maintenance. If the engine must be ran, make sure the area is well ventilated. The exhaust contains poisonous carbon monoxide gas.

After engine has been used, clean it immediately with a cloth to prevent corrosion and remove sediment.

Item	Daily check	20hrs or first month	50 hrs or every 3 months	100hrs or every 6 months	300hrs or every 1 year
Machine oil check	* check				
Replace engine oil		* replace		* replace	
Air cleaner check	* check				
Air cleaner wash			* clean		
Oil filter cup				* clean	
Oil filter				* clean	
Spark plug				* clean	
Valve clearance					Check/adjust
Cylinder cover wash					* clean
Fuel tank wash	Wash if necessary, replace every 3 years				

## \* Machine oil replacement

1. Turn and then take out the dipstick.

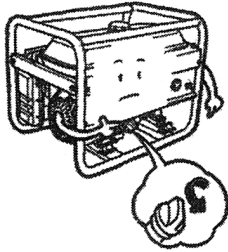

2. Turn off the drain plug, and empty the machine oil in the crankshaft.

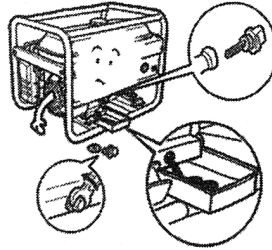

3. Screw on the drain plug.

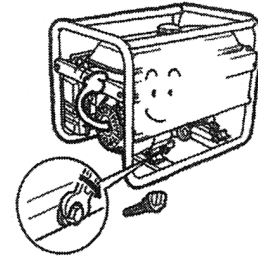

4. Fill machine oil up to the upper level

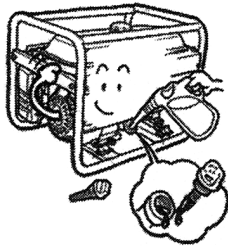

5. Reinstall the dipstick

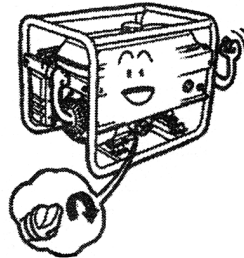

Machine oil:4 stroke gasoline engine oil-SE,SF from API Service Classification or SAE 10W-30 equivalent to SG class.

Low air temperature (below 10\* ):recommended machine oil SAE10W-30

Frigid air temperature(below -15\* ):SE,SF from API Service Classification or SAE10W-30 equivalent to SG class.

\* Air cleaner (refer to page 8:Air cleaner)

\* Spark plug

1.Dismantle the spark plug high-pressure cap.

2.Dismantle the spark plug.

3.Clear away carbon sediment.

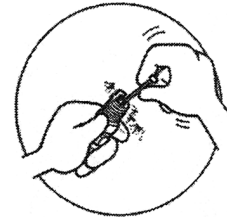
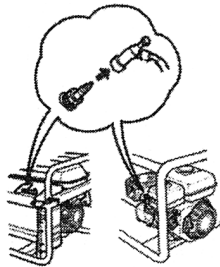



4.Measure the electrodes clearance.

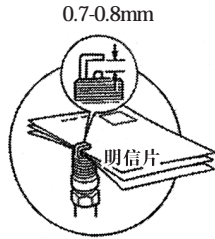

5.Reinstall the spark plug and high-pressure cap.

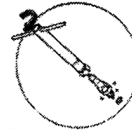

\* Fuel filter maintenance

1.Set the fuel cock to "off" position,and dismantle the fuel filter cup.

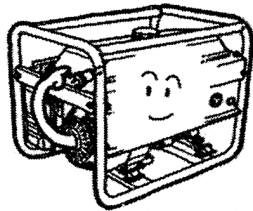

2.Clean the fuel filter cup thoroughly.

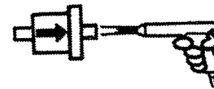

3. Mount a new rubber ring and the filter cup securely

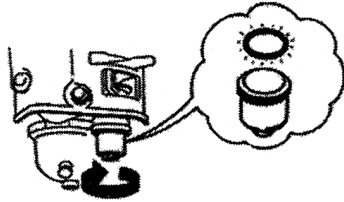

\* Maintenance for a long time storage







If the generator should be stored for a long time, the following preparation should be made:

1. Screw off the fuel drain plug, and empty the fuel inside the carburetor.
2. Turn off the oil filter plug and oil drain plug, and empty the machine oil inside the crankcase.
3. Reinstall the oil drain plug.
4. Fill in the machine oil up to the upper level mark of the dipstick.
5. Pull out the starter handle gently until resistance is felt.

## PART 7 TROUBLESHOOTING

Cause		Remedy
Engine can't start	Fuel oil is not enough	Refuel
	The switch is not at "on" position	Turn it to "on" position
	Lube oil is not enough	Check and fill in lube oil to proper level
	The speed and force to pull the recoil starter is not enough	Start the engine according to requirement of proper starting
	Spark plug has carbon sediment	Dismantle, check and clean spark plug.
No power generated	Main switch is not closed	Put the main switch to "on" position
	The contract of socket is not good.	Adjust the feet of socket
	The rated speed of generator can not be reached	Adjust it according to the requirements.

## PART 8 MAIN SPECIFICATIONS

Model	1800		2000		BG2000-ECO		BG2000		3000		BG3000		4500		6200		BG6000R		
Voltage (V)	110/220,120/240,220,230																		
Frequency (Hz)	50	60	50	60	50	60	50	60	50	60	50	60	50	60	50	60	50	60	
Rated output (KW)	1.3	1.5	1.5	1.7	1.8	2.1	2.0	2.3	2.2	2.4	2.6	3.0	3.2	3.5	4.5	5.2	5.0	5.5	
Max. output (KW)	1.5	1.8	1.8	2.0	2.2	2.5	2.4	2.7	2.6	3.0	3.0	3.3	3.8	4.5	5.2	6.2	6.0	7.2	
Engine	Model	168						170				177		188					
	TYPE	Air cooled,4-stroke,OHV,single cylinder,gasoline																	
	Max. power	6.5hp						7hp				9.0hp		13.0hp					
	Displacement	196cc						208cc				270cc		389cc					
	Fuel consump.	<230 g/hp.h																	
	Ignition system	Non-contact transistor																	
	Bore * stroke	68x54						70 x 54				73 x 58		88 x 64					
	Lube oil capa.	0.6 liter										1.1liter							
Starting	Recoil						Recoil or electric												
Fuel tank capacity	3.6  						15 liters  						25 liters  						

### GUARANTEE

Refer to the enclosed guarantee conditions for the terms and conditions of guarantee.

### ENVIRONMENT

Should your machine need replacement after extended use, do not put it in the domestic waste but dispose of it in an environmentally safe way.



Rue de Gozée, 81  
6110 Montigny-le-Tilleul  
Belgique

Tél : 0032 71 29 70 70  
Fax : 0032 71 29 70 86



Site S.A.V. D.N.V. Website  
**www.eco-repa.com**  
Your after sale partner

**FR**

Vous trouverez les mises à jour des modes d'emploi, les vues éclatées ainsi que des informations concernant les pièces de rechange sous : [www.eco-repa.com](http://www.eco-repa.com)

**NL**

U kunt updates van handleidingen, exploded views en informatie over onderdelen onder : [www.eco-repa.com](http://www.eco-repa.com)

**GB**

You can find updates of manuals, exploded views and information on spare parts under : [www.eco-repa.com](http://www.eco-repa.com)

**D**

Sie können Updates von Handbüchern zu finden, Explosionszeichnungen und Informationen zu Ersatzteilen unter : [www.eco-repa.com](http://www.eco-repa.com)

**IT**

È possibile trovare gli aggiornamenti dei manuali, esplosi e informazioni su pezzi di ricambio in: [www.eco-repa.com](http://www.eco-repa.com)

**ES**

Usted puede encontrar actualizaciones de los manuales, explotó opiniones e información sobre piezas de recambio en : [www.eco-repa.com](http://www.eco-repa.com)

**P**

Você pode encontrar atualizações de manuais, vistas explodidas e informações sobre peças de reposição sob : [www.eco-repa.com](http://www.eco-repa.com)

# BUNLD WORKER

81, rue de Gozée  
6110 Montigny-le-Tilleul  
Belgique

Tél : 0032 71 29 70 70

Fax : 0032 71 29 70 86

**Made in China**

## S.A.V

 32 / 71 / 29 . 70 . 88

 32 / 71 / 29 . 70 . 99



**Service Parts separated**

 32 / 71 / 29 . 70 . 83

 32 / 71 / 29 . 70 . 86

**2010**

**Made in China**



# GENERADOR A GASOLINA

BG2000 BG2000ECO BG3000 BG6000R

MANUAL OPERATIVO

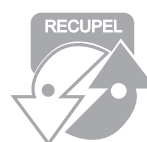

# CONTENIDO

PARTE 1	CONSEJOS DE SEGURIDAD
PARTE 2	PRESENTACIÓN DE PARTES Y COMPONENTES
PARTE 3	INSPECCIÓN ANTES DE OPERAR
PARTE 4	ARRANQUE DEL GENERADOR
PARTE 5	DETENCIÓN DEL GENERADOR
PARTE 6	REVISIONES Y MANTENIMIENTOS PERIÓDICOS
PARTE 7	IDENTIFICACIÓN Y SOLUCIÓN DE PROBLEMAS
PARTE 8	ESPECIFICACIONES PRINCIPALES
PARTE 9	TÉRMINOS & CONDICIONES DE VENTA & USO



## PARTE 1 CONSEJOS DE SEGURIDAD

Gracias por escoger nuestro generador a gasolina. Por favor, lea este manual detenidamente antes de usar, y familiarícese con los métodos correctos y los consejos de operación y mantenimiento.

Precauciones: Si no se acatan las notas y precauciones de seguridad listadas abajo, se pueden presentar lesiones personales o daños graves del motor. Por favor, ponga mucha atención a lo siguiente:

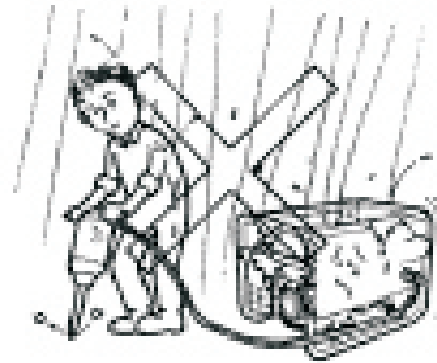
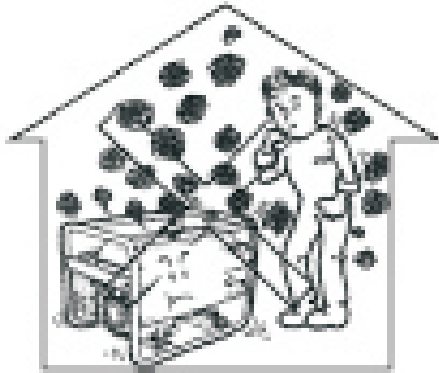

\* Nunca opere en un área cerrada o con poca ventilación.

\* No opere bajo climas húmedos (lluvia, nieve).

\* Nunca conecte al circuito eléctrico de la casa, si no se interrumpe el suministro eléctrico comercial.

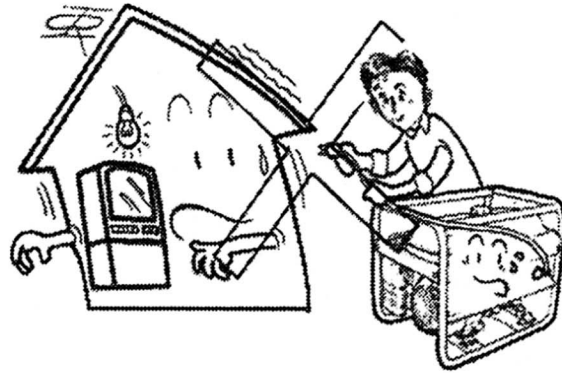

\* Mantenga al menos 1 metro lejos de elementos inflamables.

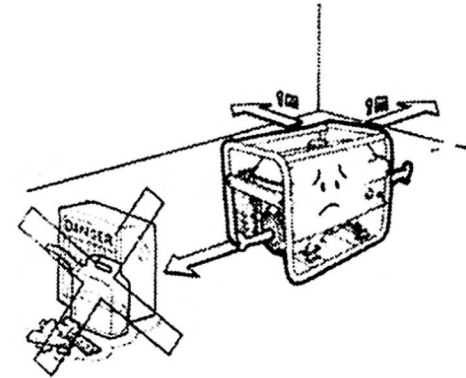

\* Recuerde parar el motor antes de abastecer de combustible.

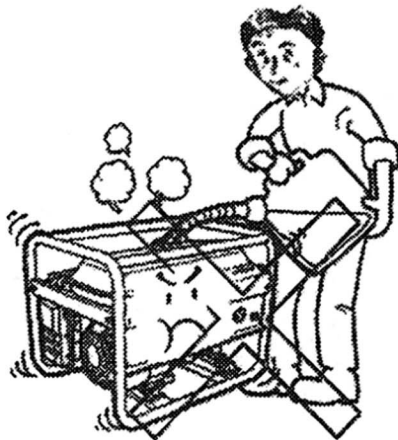

\* No fume mientras abastece de combustible.

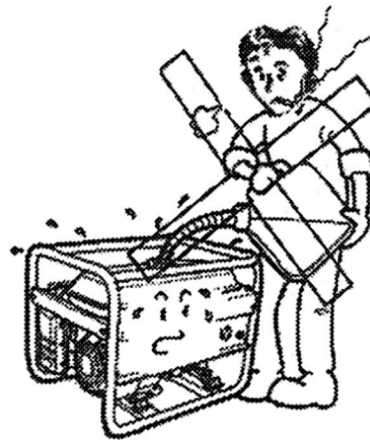

\* Evite derramar el combustible al ponerlo.

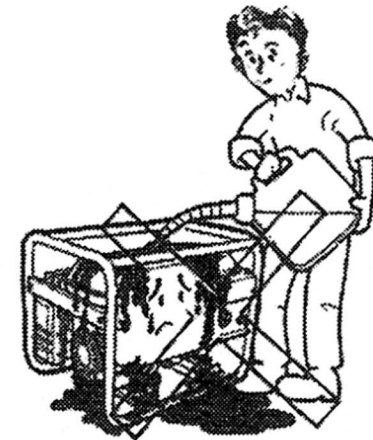

## **Precaución:**

### **1. Evite incendios**

El combustible del motor es gasolina, por lo tanto no use diesel, kerosén ni otros. Limpie el combustible derramado con un trapo limpio. Mantenga todos los elementos inflamables alejados del generador, debido a que la temperatura alrededor del silenciador del tubo de escape puede ser alta durante la operación.

Opere el generador en una superficie nivelada. Si el generador se inclina, se puede derramar el combustible. 2. Evite la inhalación de gas del tubo de escape

El gas del tubo de escapa contiene monóxido de carbono venenoso. Nunca use el generador en áreas poco ventiladas.

Evite operar en áreas internas donde sea posible y suministre buena ventilación. 3. Evite las quemaduras

Nunca toque el silenciador o su cubierta cuando el motor esté funcionando o se haya detenido en ese momento. 4. Descargas eléctricas, cortos circuitos

Para evitar descargas eléctricas o cortos circuitos, no toque el generador con las manos mojadas o cuando éste se encuentre mojado.

Este generador no es resistente al agua, de tal forma que no lo use expuesto a la lluvia, nieve ni aspersiones de agua.

El generador debe conectarse a tierra para evitar descargas eléctricas. Por favor, conecte un cable para longitudes largas entre el terminal de tierra del generador y el dispositivo de tierra externo.

No conecte otros dispositivos al generador antes de arrancarlo. 5.

### **Otras recomendaciones de seguridad**

Conozca bien como parar el generador así como la operación de todos sus controles. Nunca permita que nadie use el generador sin la instrucción apropiada.

Siempre use calzado de seguridad y ropa apropiada. Mantenga a los niños y mascotas alejados del

generador cuando esté funcionando.

## PARTE 2

## PRESENTACIÓN DE PARTES Y COMPONENTES

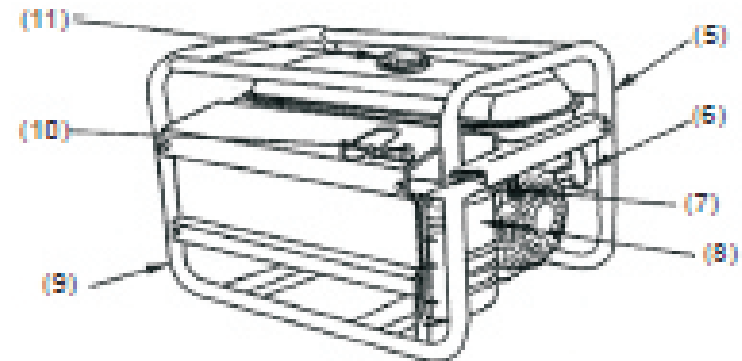
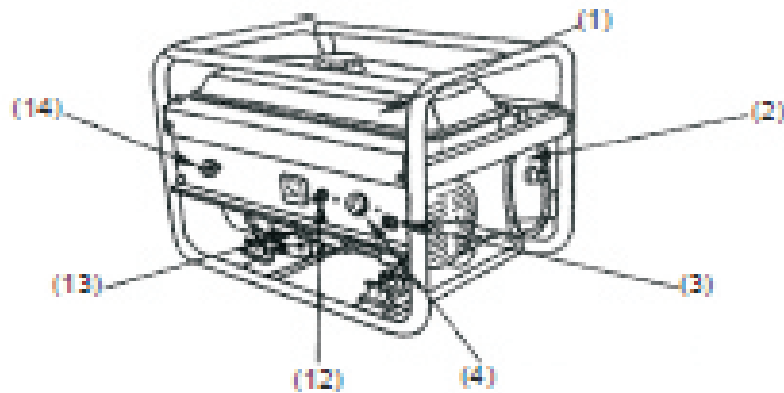

1. Tanque de combustible 2. Silenciador 3. Terminal a tierra 4. Enchufe/toma A.C 5. Válvula reguladora del carburador  
6. Manija de encendido 7. Llave del combustible 8. Filtro de aire 9. Soporte del tubo

10. Bujía

11. Tapa del tanque de combustible 12. Disyuntor AC 13. Varilla medidora del aceite

14. Interruptor de encendido

### PARTE 3

### INSPECCIÓN ANTES DE OPERAR

#### Nivel de aceite de la máquina

Siempre revise el nivel de aceite de la máquina después de detener el generador en el suelo.

1 Quite la tapa del filtro de aceite y limpie la varilla medidora de aceite con un trapo limpio.

2. Inserte la varilla medidora de aceite de nuevo en el orificio del filtro sin girar.

limpio.

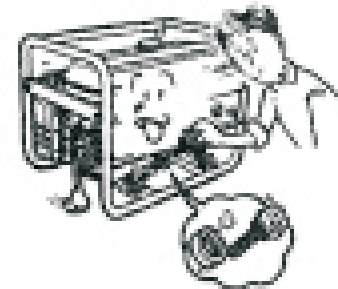
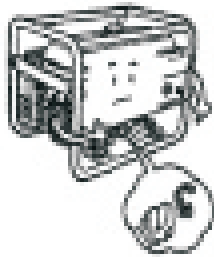

3. En caso de que el nivel de aceite sea inferior a la marca del nivel de la varilla, ponga combustible hasta la parte superior de la marca.

4. Reinstale la tapa del filtro de aceite.

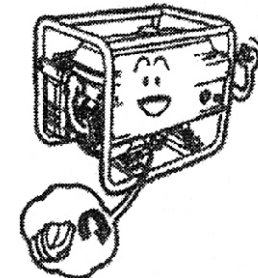
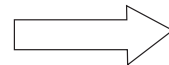
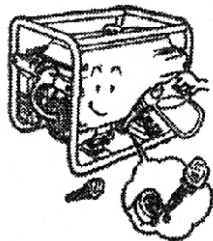

## \* Nivel de aceite de combustible

1. Abra la tapa del tanque de combustible.  
reabastezca si es necesario.

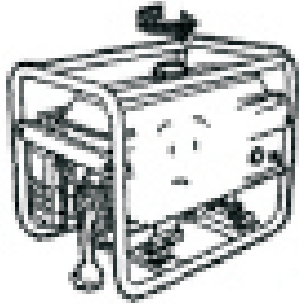

2. Revise el nivel de combustible y  
reabastezca si es necesario.

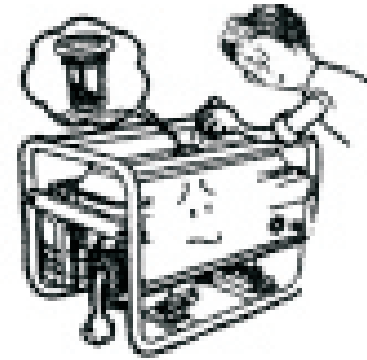

3. Ponga combustible hasta la franja del filtro de combustible.

4. Reinstale la tapa del  
filtro de combustible.

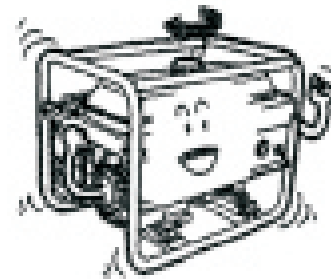
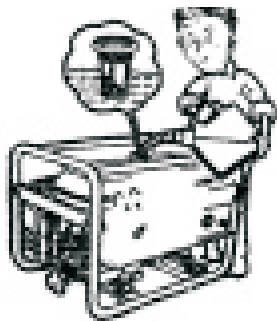

## \* Filtro de aire

1. Quite el clip y desarme la carcasa del filtro de aire o suelte las tuercas y la cubierta del filtro de aire.

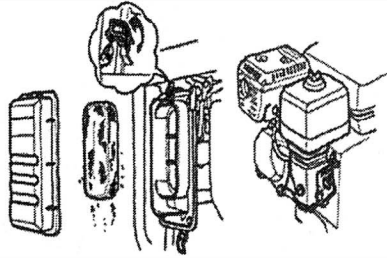

2. Quite la tuerca y arandela y suelte el elemento del filtro.

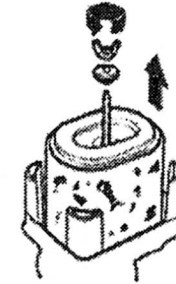

3. Quite el elemento del filtro.

4. Lave

5. Golpee suavemente el elemento del filtro

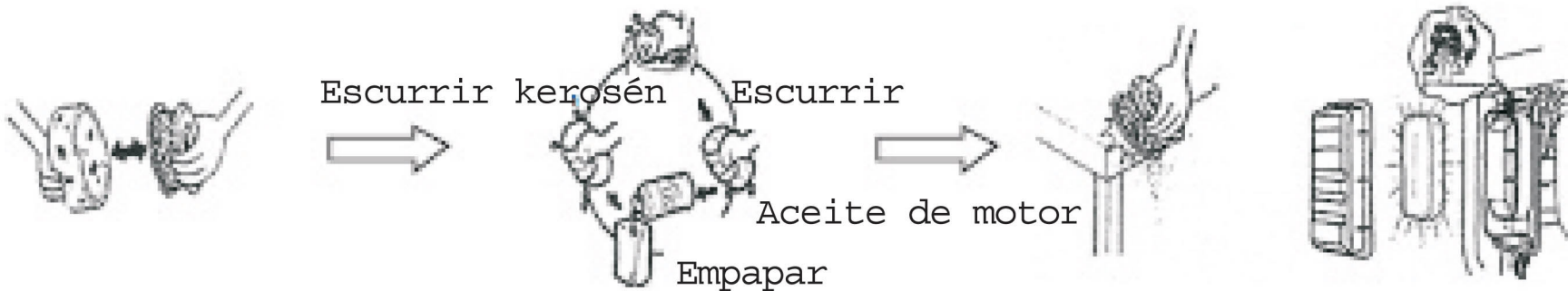

## PARTE 4

## ARRANQUE DEL GENERADOR

1. Quite todas las cargas de la toma AC y desactive el disyuntor AC.

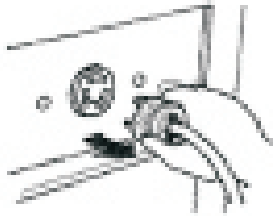

2. Ponga la llave del combustible en la posición "on".

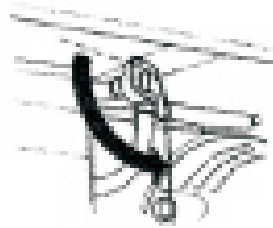

3. Presione la palanca del estárter para dejarla en posición "activar (estárter)"

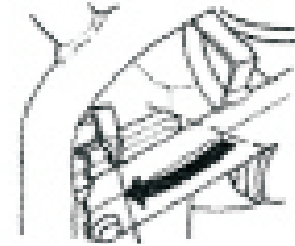

Válvula de regulación del carburador

4. Gire el interruptor de arranque del generador a la posición "on".

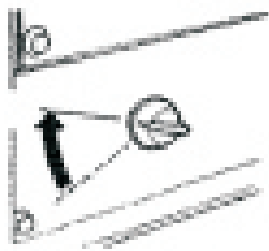

5. Hale la manija del estárter hasta que sienta resistencia, luego hálelo rápida y completamente.

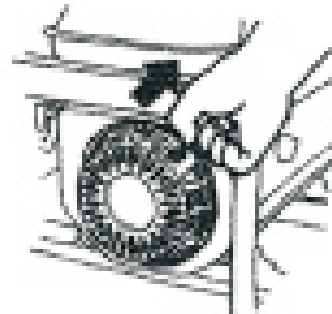

6. Una vez que arranque el generador, ponga el estárter en la posición "off".

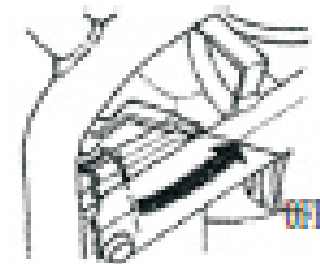



## **Consejos y precauciones operativas:**

1 .No arranque dos o más máquina simultáneamente. Hágalo una por una.

2 Caliente el motor sin carga durante cerca de 3 minutos. Si el generador se va a usar para suministrar energía a más de un equipo, asegúrese de conectarlos uno por uno con corriente nominal primero.

La mayoría de los motores de equipos, necesitan más de su potencia para arrancar. No sobrepase el límite de corriente especificado para una toma. 3. Asegúrese que todos los equipos estén en buenas condiciones antes de conectarlos al generador. Si el equipo empieza a funcionar anormalmente (se vuelve lento o se para repentinamente), apague el interruptor principal del generador inmediatamente. Luego desconecte el equipo y examine si hay señales de mal funcionamiento.

Si se sobrecarga el protector del circuito AC, reduzca la carga eléctrica del circuito y espere unos minutos antes de reanudar la operación.

Si la indicación del voltímetro es muy baja o muy alta, detenga la máquina y examine la causa del mal funcionamiento. El generador puede cargar cuando el indicador del voltímetro muestre 230iAi 0%(50hz) en el panel de la caja de control. 4. Aplicación DC: No use 12v DC y AC simultáneamente.

El terminal DC se puede usar para cargar solamente baterías automáticas de 12 volt. Cuando use baterías automáticas con cables de baterías, asegúrese de desconectar el polo negativo de la batería, antes de cargar. No invierta los cables de carga porque puede dañar el generador y/o la batería. 5.

Cuando conecte el generador a un circuito de energía del hogar, verifique que el trabajo lo haga una persona calificada. Las conexiones inapropiadas entre el generador y el equipo, pueden dañar el generador o el equipo e incluso causar incendios.

Advertencia: Si el generador se ha conectado a una red eléctrica, verifique que el interruptor principal de energía esté en off. De lo contrario, el reinicio del suministro eléctrico repentino, puede dañar el generador o el equipo incluso causar incendios.

## PARTE 5

## DETENCIÓN DEL GENERADOR

1. Desactive el disyuntor AC.

2. Apague el generador.

3. Ponga la llave del combustible en la posición "off".

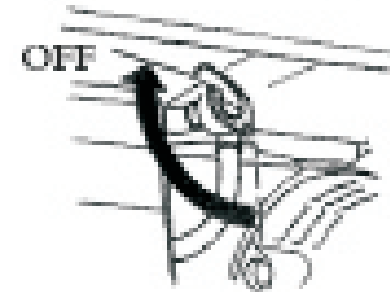
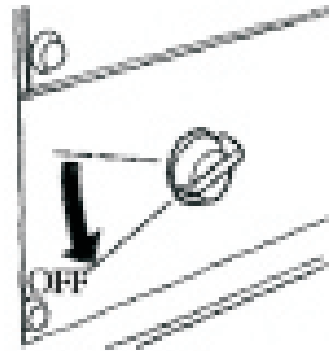
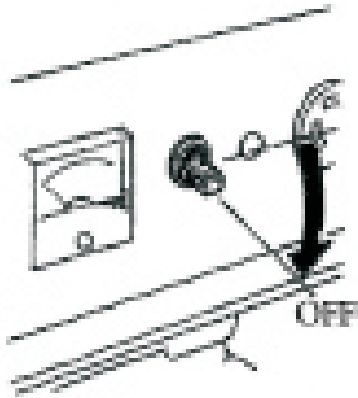

Nota: Para detener el generador en emergencias, póngalo en la posición "off".

## PARTE 6

## REVISIONES Y MANTENIMIENTOS PERIÓDICOS

### \* REVISIONES Y MANTENIMIENTOS PERIÓDICOS

Las revisiones y mantenimientos periódicos son muy importantes para mantener el motor en buenas condiciones operativas y seguras. El generador está compuesto de motor a gasolina, alternador, panel de control, estructura, etc.

Apague el motor antes de hacer mantenimiento. Si va a arrancar el motor, verifique que el área esté bien ventilada. El tubo de escape contiene gases de monóxido de carbono venenosos.

Después de usar el motor, límpielo inmediatamente con un trapo para evitar la corrosión y elimine los sedimentos.

Elemento	Revisión diaria	20hrs o primer mes	50 hrs o cada 3 meses	50 hrs o cada 6 meses	300hrs o cada año
Revisión del aceite de la máquina	* revisar				
Reemplazar el aceite del motor		* reemplazar		* reemplazar	
Revisar el filtro de aire	* revisar				
Lavar el filtro de aire			* limpiar		
Copa del filtro de aceite				* limpiar	
Filtro del aceite				* limpiar	
Bujía				* limpiar	
Juego de válvulas					Revisar/ajustar
Lavar la cubierta del cilindro					* limpiar
Lavar el tanque de combustible	Lave si es necesario, reemplace cada 3 años				

## \* Reemplazo del aceite de la máquina

1. Gire y saque la varilla medidora de aceite.

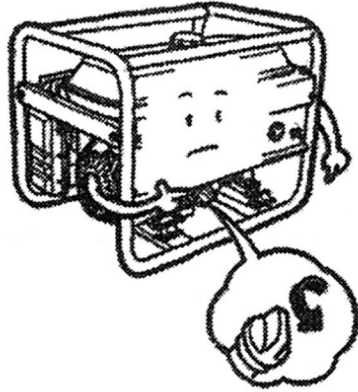

2. Quite el tapón de drenaje y evacúe el aceite del cigüeñal de la máquina.

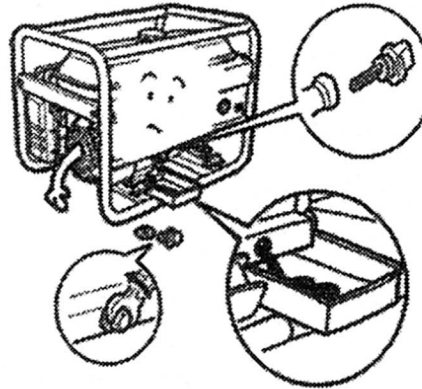

3. Atornille el tapón de drenaje.

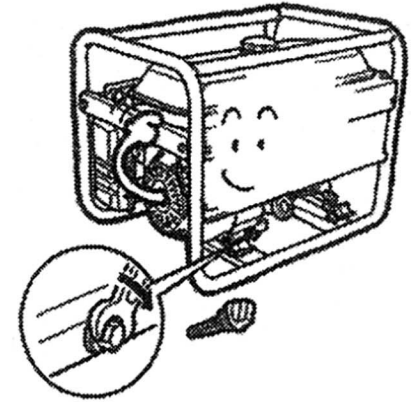

4. Ponga aceite hasta el nivel superior

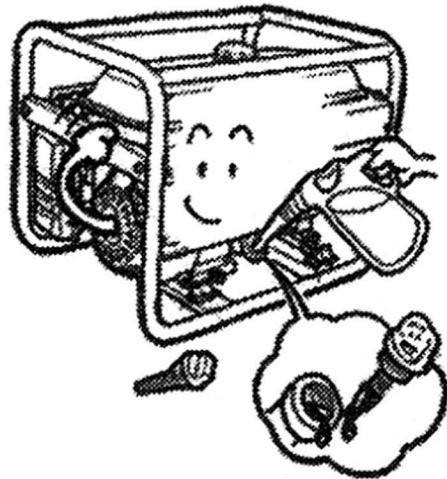

5. Reinstale la varilla medidora de aceite

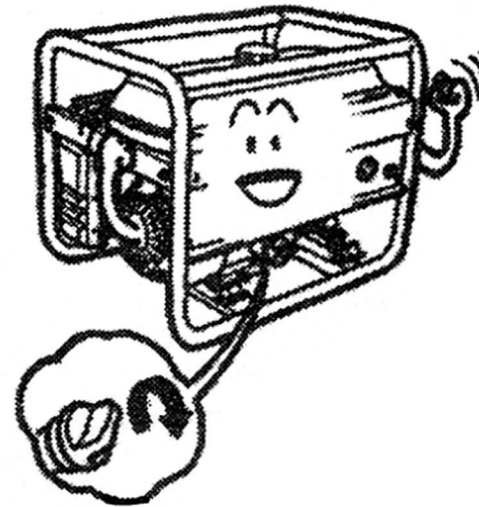

Aceite de la máquina: Aceite SE-SF de cuatro tiempos para motores a gasolina, clasificación de servicios API o SAE 10W-30 equivalente a la clase SG.

Temperatura de aire baja (inferior a 10\* ): aceite recomendado S AE10W-30

Temperatura de aire muy fría (inferior a -15\* ):SE,SF de clasificación de servicio API o SAE10W-30 equivalente a la clase SG.

\* Filtro de aire (ver página 8: Filtro de Aire)

\* Bujía

1 Quite la tapa de alta presión de la bujía.

2. Quite la bujía.

3. Limpie los sedimentos de carbono.

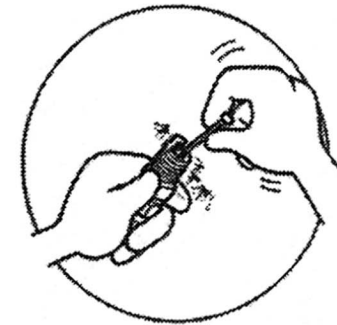
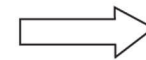
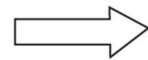
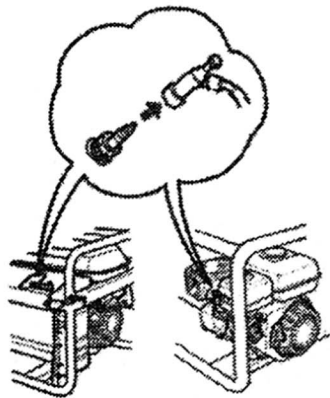

4. Mida la tolerancia de los electrodos.

0.7-0.8mm

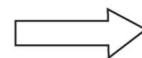
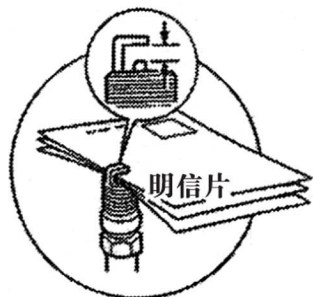

1 Reinstale la bujía y la tapa de alta presión .

### \* **Mantenimiento del filtro de combustible**

1. Ponga el estarter en "off" y quite la copa del filtro de combustible de combustible.

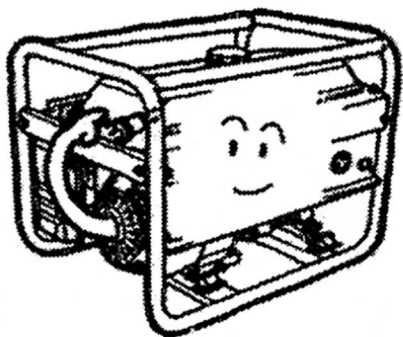

2. Limpie la copa del filtro de combustible completamente.

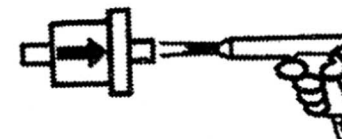

### 3. Instale un nuevo empaque y la copa del filtro

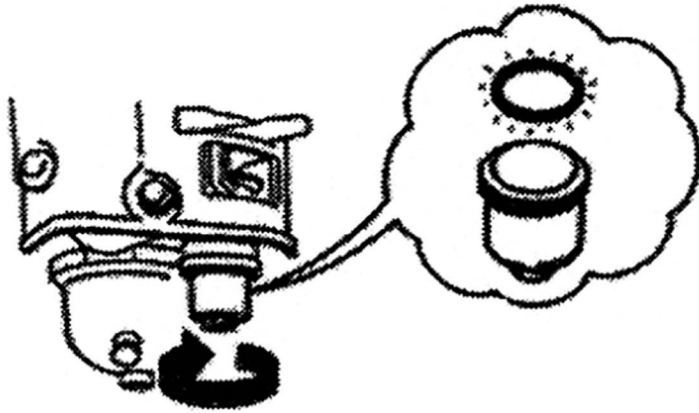

\* Mantenimiento para almacenamientos prolongados

Si el generador se va a almacenar por largo tiempo, debe hacerse lo siguiente:







1. Quite el tapón de drenaje y evacúe el combustible del carburador.
2. Quite el tapón del filtro de aceite y el de drenaje y evacúe el aceite del cárter.
3. Atornille el tapón de drenaje.
4. Llene la máquina con aceite hasta el nivel superior de la marca de la varilla medidora de aceite.
5. Hale la manija del estárter suavemente hasta que sienta resistencia.

## PARTE 7 IDENTIFICACIÓN Y SOLUCIÓN DE PROBLEMAS

Causa		Remedio
El motor no arranca	No hay suficiente combustible	Reabastezca
	El interruptor no está en "on"	Póngalo en "on"
	No hay suficiente aceite lubricante	Revise y ponga aceite lubricante hasta el nivel apropiado
	La velocidad y fuerza del estárter de repliegue no son suficientes	Arranque el motor de acuerdo con los requerimientos apropiados
	La bujía tiene sedimentos de carbono	Desarme, revise y limpie la bujía.
No se genera energía	El interruptor principal está en "off"	Ponga el interruptor en "on"
	El contacto de la toma no es bueno.	Ajuste la base de la toma
	No se puede alcanzar la velocidad nominal del generador	Ajuste de acuerdo a los requerimientos.



## PARTE 8 ESPECIFICACIONES PRINCIPALES

Modelo	1800	2000	BG2000-ECO	BG2000	3000	BG3000	4500	6200	BG6000R									
Voltaje (V)	110/220,120/240,220,230																	
Frecuencia (Hz)	50	60	50	60	50	60	50	60	50	60								
Salida nominal(KW)	1.3	1.5	1.5	1.7	1.8	2.1	2.0	2.3	2.2	2.4	2.6	3.0	3.2	3.5	4.5	5.2	5.0	5.5
Salida máxima(KW)	1.5	1.8	1.8	2.0	2.2	2.5	2.4	2.7	2.6	3.0	3.0	3.3	3.8	4.5	5.2	6.2	6.0	7.2
MOTOR	Modelo	168					170			177		188						
	TIPO	a gasolina, cilindros simples. ohv 4 tiempos, aire refrigerado.																
	Potencia máx	6.5hp					7hp			9.0hp		13.0hp						
	Desplazamie	196cc					208cc			270cc		389cc						
	Consumo de	<230 g/hp.h																
	Sistema de	Transistor sin contactos																
	Calibre *	68x54					70x54			77x58		88x64						
	Capacidad	0.6 litros									1.1 litro							
	Arrancando..	Repliegue					Repliegue o eléctrico											
	<b>3.6L</b>  					<b>15L</b>  			<b>25L</b>  									

### GARANTÍA

Consulte las condiciones de garantía incluidas para conocer los términos que cubren la garantía del equipo.

### MEDIO AMBIENTE

Si su máquina necesita partes de repuesto después de uso prolongado, no deseche las partes en la cesta de desechos domésticos sino hágalo de manera apropiada para proteger el medio ambiente.

Rue de Gozee, 81  
6110 Montigny-le-Tilleul  
Bélgica  
Tel: 0032 71 29 70 70  
Fax: 0032 71 29 70 86



Site S.A.V. D.N.V. Website  
**www.eco-repa.com**  
Your after sale partner

**FR**

Vous trouverez les mises à jour des modes d'emploi, les vues éclatées ainsi que des informations concernant les pièces de rechange sous : [www.eco-repa.com](http://www.eco-repa.com)

**NL**

U kunt updates van handleidingen, exploded views en informatie over onderdelen onder : [www.eco-repa.com](http://www.eco-repa.com)

**GB**

You can find updates of manuals, exploded views and information on spare parts under : [www.eco-repa.com](http://www.eco-repa.com)

**D**

Sie können Updates von Handbüchern zu finden, Explosionszeichnungen und Informationen zu Ersatzteilen unter : [www.eco-repa.com](http://www.eco-repa.com)

**IT**

È possibile trovare gli aggiornamenti dei manuali, esplosi e informazioni su pezzi di ricambio in: [www.eco-repa.com](http://www.eco-repa.com)

**ES**

Usted puede encontrar actualizaciones de los manuales, explotó opiniones e información sobre piezas de recambio en : [www.eco-repa.com](http://www.eco-repa.com)

**P**

Você pode encontrar atualizações de manuais, vistas explodidas e informações sobre peças de reposição sob : [www.eco-repa.com](http://www.eco-repa.com)



81, rue de Gozée  
6110 Montigny-le-Tilleul  
Belgique

Tél : 0032 71 29 70 70

Fax : 0032 71 29 70 86

**Made in China**

**S.A.V**

 32 / 71 / 29 . 70 . 88

 32 / 71 / 29 . 70 . 99



**Service Parts separated**

 32 / 71 / 29 . 70 . 83

 32 / 71 / 29 . 70 . 86

**2010**

**Made in China**